

## SPICE thermal model

BUK961R7-40E

Symbol	Parameter	Conditions	Min	Typ	Max	Unit
$R_{th(j-mb)}$	thermal resistance from junction to mounting base		-	-	0.46	K/W

$C_{th1}$	2.404E-04 F
$C_{th2}$	1.735E-03 F
$C_{th3}$	1.299E-03 F
$C_{th4}$	4.873E-03 F
$C_{th5}$	1.648E-02 F
$C_{th6}$	2.996E-02 F
$C_{th7}$	6.007E-01 F
$C_{th8}$	1.529E+02 F
$R_{th1}$	3.714E-04 $\Omega$
$R_{th2}$	7.331E-04 $\Omega$
$R_{th3}$	8.493E-03 $\Omega$
$R_{th4}$	2.053E-02 $\Omega$
$R_{th5}$	6.988E-02 $\Omega$
$R_{th6}$	2.879E-01 $\Omega$
$R_{th7}$	8.385E-02 $\Omega$
$R_{th8}$	1.433E-03 $\Omega$

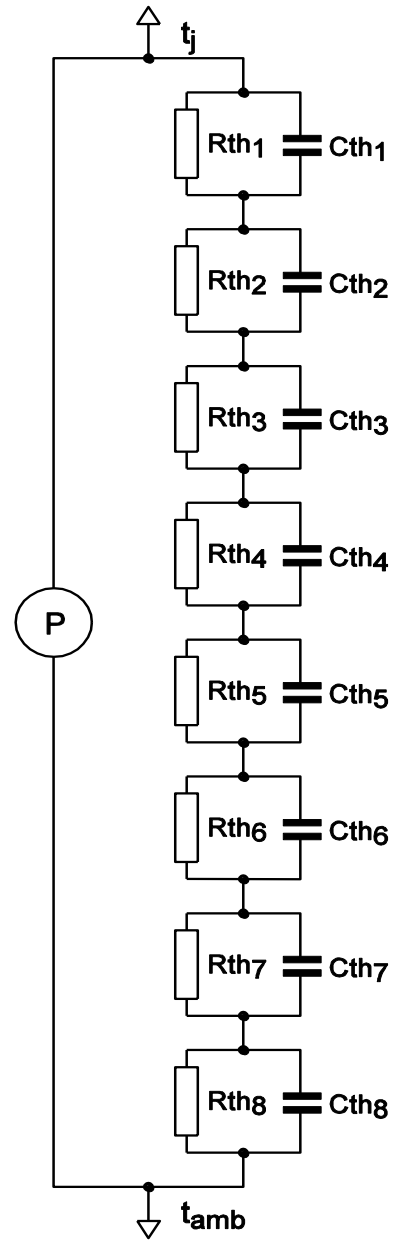

Part: BUK961R7-40E  
 Date: 11/4/2013  
 Model Rth 0.47 K/W